

# HP Archive

This vintage Hewlett Packard document was  
preserved and distributed by

**[www. hparchive.com](http://www.hparchive.com)**

Please visit us on the web !

On-line curator: Joe Geller

INSTRUCTION AND OPERATING MANUAL

FOR

MODEL 200D

AUDIO OSCILLATOR

Serial 70,000 and Above

HEWLETT-PACKARD COMPANY  
395 PAGE MILL ROAD, PALO ALTO, CALIFORNIA, U.S.A.

# INSTRUCTIONS

## MODEL 200D

### AUDIO OSCILLATOR

#### Specifications

##### Frequency Rating --

Frequency Range - 7 to 7,000 cycles/sec.

Frequency Dial Calibration - 7 to 70

Range-

x1	7 to 70 cycles/sec.
x10	70 - 700 cycles/sec.
x100	700 - 7,000 cycles/sec.
x1000	7,000 - 70,000 cycles/sec.

Calibration Accuracy -  $\pm 2\%$

Frequency Response -  $\pm 1$  db-7 to 70,000 cycles/sec. Reference:  
10 volts at 1000 cycles/sec. into 1000 ohms load.

Frequency Stability -  $\pm 2\%$  under the normal temperature conditions including initial warm-up drift.  $\pm 10\%$  line voltage variations will change the frequency less than  $\pm .2\%$  at 1000 cycles/sec.

##### Power Output Rating--

Power Output-100 milliwatts into rated load. (10 volts into a 1000 ohms load).

Distortion-Less than .1% of rated output, 10 to 70,000 cycles/sec.

Hum voltage-Less than .1% of rated output.

Load Impedance-1000 ohms, resistive

Internal Impedance-Approximately 25 ohms, 50 to 70,000 cycles/sec.

One side of output grounded.

##### Power Supply Rating--

Voltage-105 to 125 volts

Frequency-50/60 cycles

Wattage-80 watts

##### Overall Dimensions--

Rack Model-19" wide x 8-3/4" high x 12-1/4" deep

Panel-19" x 8-3/4", depth behind panel-10-1/2"

Cabinet Model-18-3/4" wide x 8-3/4" high x 12" deep

Weight --

Cabinet Model - 25 pounds

Rack Model - 27 pounds

Operating Instructions

Inspection --

This instrument has been thoroughly tested and inspected before being shipped and is ready for use when received.

After the instrument is unpacked, the instrument should be carefully inspected for damage received in transit. If any shipping damage is found, follow the procedure outlined in the "Claim for Damage in Shipment" page at the back of this instruction book.

Controls and Terminals --

AC Power - This toggle switch, which is located in the lower left corner of the control panel, controls the power supplied to the instrument from the power line. When the switch is in the ON position, the red indicator will glow.

FUSE - The fuseholder, located on the back of the chassis, contains a one ampere cartridge fuse. The fuse may be replaced by unscrewing the fuseholder cap and inserting a new fuse.

RANGE - This rotary switch inserts various range resistors in the frequency determining circuit of the oscillator. The position of this switch indicates the multiplying factor for the frequency dial calibration and which frequency dial scale should be used.

Frequency Dial - The frequency dial is calibrated directly in cycles per second for the lowest frequency range.

AMPL - This variable resistor controls the amplitude of the oscillator voltage admitted to the amplifier and therefore the output voltage of the instrument.

Power Cable - The power cable consists of three conductors. Two of these conductors carry power to the instrument while the third conductor (green wire) is connected to the instrument chassis. The third wire projects from the cable near the plug end of the cable and may be connected to a ground when it is desirable to have a grounded instrument chassis.

Output Terminals - The two binding posts, in the lower right corner of the control panel, are the output terminals. The lower binding post is connected to the chassis.

1000 10/13/50 Serial 79,000 Zs

Operation --

Plug the power cable of the Model 200D into a 115 volts, 50/60 cycles power source and turn on the AC power switch. The instrument will begin to operate as soon as the tubes have heated, but for maximum accuracy a warm-up period of about 30 minutes is necessary.

Set the frequency dial and RANGE switch so that their indications, when multiplied together, equals the desired frequency. For example, if it is desired to select an output frequency of 1000 cycles per second, set the frequency dial to 10 and the RANGE switch to x10.

Connect the output of the oscillator to the equipment being driven and adjust the AMPL. control for the desired output voltage.

Although the rated load for the Model 200D is 1000 ohms, higher or lower impedance loads may be used without damage to the instrument. A higher impedance load will result in less power output and a lower impedance load will increase the percentage of distortion in the output voltage.

As the output voltage of the audio oscillator is reduced the percentage of hum voltage will increase. At the lower levels this hum voltage becomes quite large, relative to the sine wave output voltage. This undesirable condition can be remedied by operating the audio oscillator at or slightly below rated output and inserting a suitable attenuator between the oscillator and the equipment being driven by the oscillator. The voltage divider circuit shown next is satisfactory for most applications.

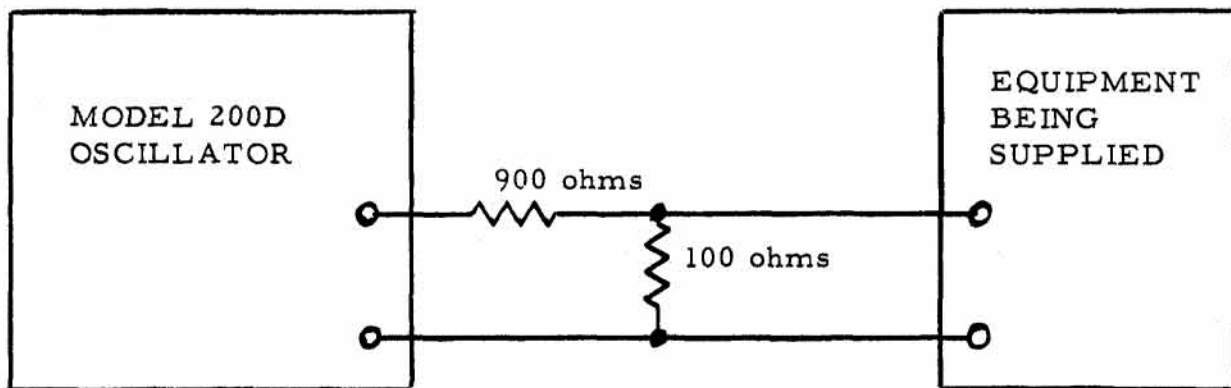

Other values of resistance may be used to obtain different voltage divisions. In all cases, the sum of the divider resistors should match the rated load of 1000 ohms.

Serial 70,000 to  
200D 10/13/50

## Circuit Description

The Model 200D Audio Oscillator consists of an oscillator section, an amplifier section, and a conventional power supply.

The oscillator section (tubes V1 and V2) is a resistance-tuned type circuit. Basically, this oscillator is a two-stage resistance-coupled amplifier which is caused to oscillate by the use of a positive feedback network. This network is a frequency-selective resistance-capacity combination which controls the frequency of oscillation. By using a variable tuning condenser for the capacity of the network, it is possible to tune the oscillator over a wide 10:1 range; and by using a switching arrangement to select different values of resistance for the network, several ranges are given to the oscillator.

Negative feedback is used in the oscillator section in order to minimize distortion and to obtain a very high order of stability. The amount of negative feedback is determined by a resistance network, one element of which is non-linear (the 6-watt lamp in the cathode of V1). This element controls the amount of feedback in accordance with the amplitude of oscillation and consequently maintains the amplitude of oscillation substantially constant over a wide frequency range. The negative feedback also keeps the operation of the system on the linear portion of the tube characteristics. It is notable that the lamp has sufficient thermal inertia so that it operates well even at low frequencies.

Following the oscillator is the output amplifier section which includes tubes V3 and V4. Negative feedback is used in the amplifier in order to minimize distortion and to provide a good frequency response.

## Maintenance

### Cover and Bottom Plate Removal --

The cover is removed by unscrewing the eight screws which fasten the cover to the back and top of the instrument.

The bottom plate is removed by unscrewing the four screws, one in each corner of the bottom plate, which fasten the plate to the chassis.

### Tube Replacement --

When replacing any of the tubes except the power rectifier, it is desirable to measure the distortion in the output if maximum performance from the instrument is desired, because a poor tube can cause excessive distortion without seemingly affecting the operation. The distortion should be less than 1% of the rated output with rated load from 10 to 70,000 cycles. Distortion may also be caused by leaking coupling capacitors and open by-pass capacitors.

### Replacement of Lamp R9--

The 6-watt lamp R9 is operated at a very low level and should have an almost infinite life. Therefore, the lamp should not be changed indiscriminately. However, should the lamp require changing, it is necessary to check the ac voltage from the junction of R21 and C9 to ground with the new lamp in the circuit. As measured with a high-impedance ac vacuum tube voltmeter, this voltage should be within the range of approximately 18 - 22 volts when the Model 200D is tuned to 1000 cps. If the voltage is not within this range, it may be corrected by adjusting R13.

If the voltage cannot be brought within the range from 18 to 22 volts by means of R13, the new lamp should be rejected in favor of another.

### Intermittent Output--

"Jumpy" or intermittent output accompanied by flashing of the 6 watt oscillator lamp (R9) is a reliable indication of a short in trimmer capacitor C2 (mounted on gear drive) or in the four front (nearest the panel) sections of the main tuning capacitor. If these symptoms occur, search out and clear the short with a weak air jet or other means. Do not bend the capacitor plates because bending capacitor plates will destroy the frequency calibration.

A short in the four rear sections of the main tuning capacitor or in trimmer C4 (mounted on chassis at rear end of tuning capacitor) will prevent the circuit from oscillating. Any such short should be cleared as explained above.

### Distortion--

Distortion may be caused by defective tubes, electrical leakage in the coupling capacitors, defective electrolytic capacitors, low DC supply voltage, or excessive output voltage from the oscillator section.

### Frequency Calibration--

If a change occurs in the frequency calibration, the instrument should be returned to the Hewlett-Packard Co. for re-calibration.

## Trouble Shooting--

The following is a listing of possible symptoms, causes and remedies.

<u>Symptoms</u>	<u>Causes</u>	<u>Remedies</u>
Instrument inoperative (Indicator light won't light, no audio output)	Blown fuse	Clear short circuit and replace fuse
Instrument inoperative (Indicator lamp lights, no audio output)	Defective tube Check 5Y3GT tube	Replace tube (see "Tube Replacement" in Main- tenance section).
	Short circuit in DC power circuit capacitor	Replace capacitor
	Short circuit in C3 (four rear sections) or C4	Clear the short circuit as outlined in the "Intermit- tent Output" paragraph in the Maintenance section.
Intermittent Output	Short circuit in C3 (four front sections) or C2	Clear the short circuit as outlined in the "Intermit- tent Output" paragraph in the Maintenance section.
	Capacitor C6, C9, C10, or C11 intermittently open	Replace capacitor
Excessive Distortion	Defective tube	Replace tube (see "Tube Replacement" in Main- tenance section).
	Open capacitor C11, C14abcd or C15	Replace capacitor
	Leaking capacitor C6, C9, C10, C11, or C12	Replace capacitor



## INSTRUCTIONS FOR RECTIFIER TUBE REPLACEMENT

These instructions apply to any Hewlett-Packard instrument in which a 5V4 tube is mounted in the power rectifier tube socket. When it is necessary to replace the rectifier tube, a 5Y3GT tube may be used as a replacement if the following instructions are followed.

### INSTRUMENTS WITH DC VOLTAGE REGULATOR CIRCUIT-

The 5V4 tube may be replaced by a 5Y3GT tube without any circuit changes. After the 5Y3GT tube has been installed, the regulated voltage should be measured to see if it agrees with the voltage shown on the schematic wiring diagram in the instruction book. If the regulated voltage is incorrect it may be corrected by following the instructions in the instruction book.

### INSTRUMENTS WITHOUT DC VOLTAGE REGULATOR CIRCUIT-

The 5V4 tube may be replaced by a 5Y3GT tube providing the resistor, in series with the DC output of the rectifier, is removed. This resistor does not appear in the schematic wiring diagram in the instruction book. The following instruments use a 500 ohms series resistor: Models 200C, 200D, 202D, 210A, 300BCD, and the 400A.

Serial 10,000 10

Dwg. 700-E-301 3/30/50

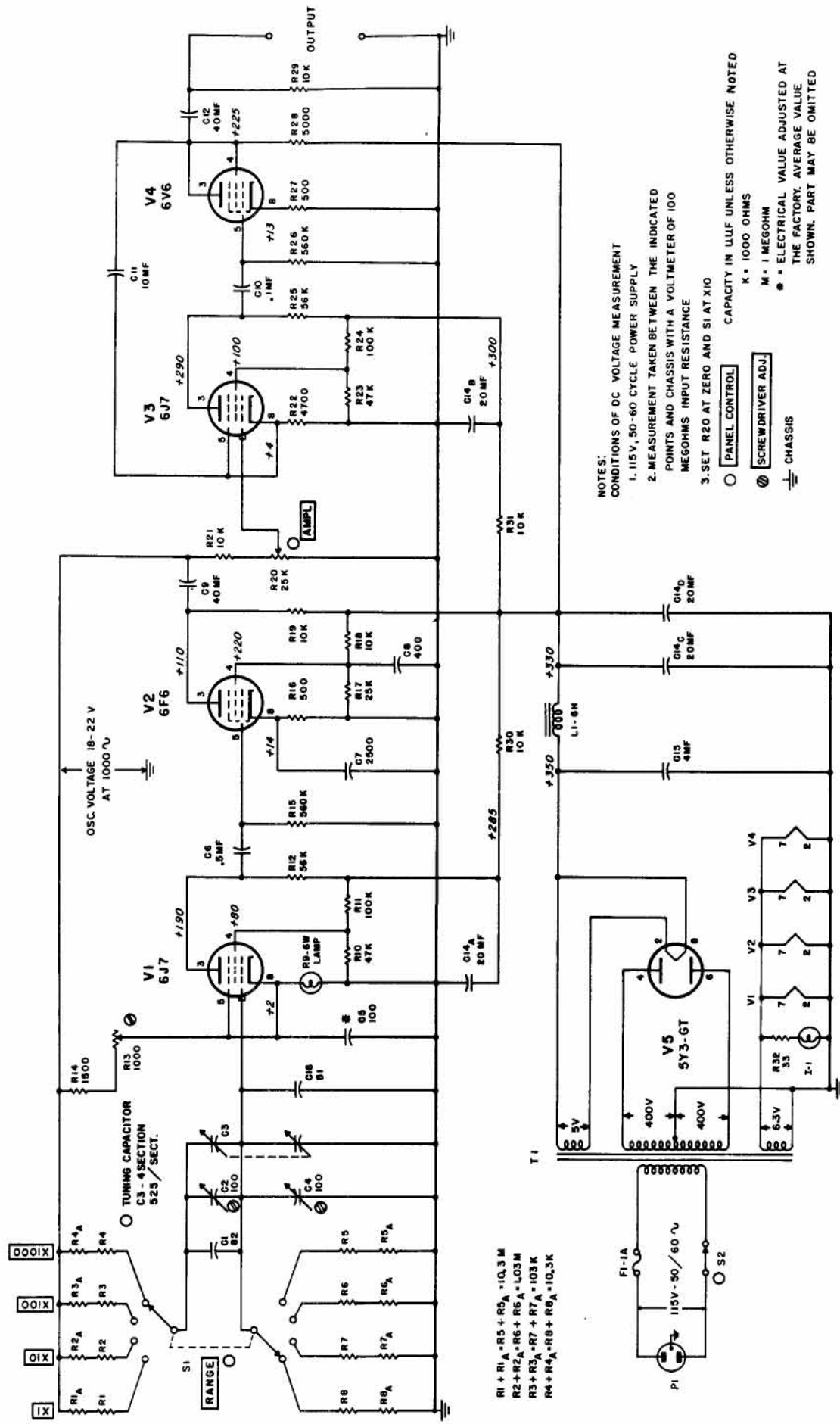

SCHEMATIC DIAGRAM OF MODEL 2000 AUDIO OSCILLATOR SERIAL 70000 TO

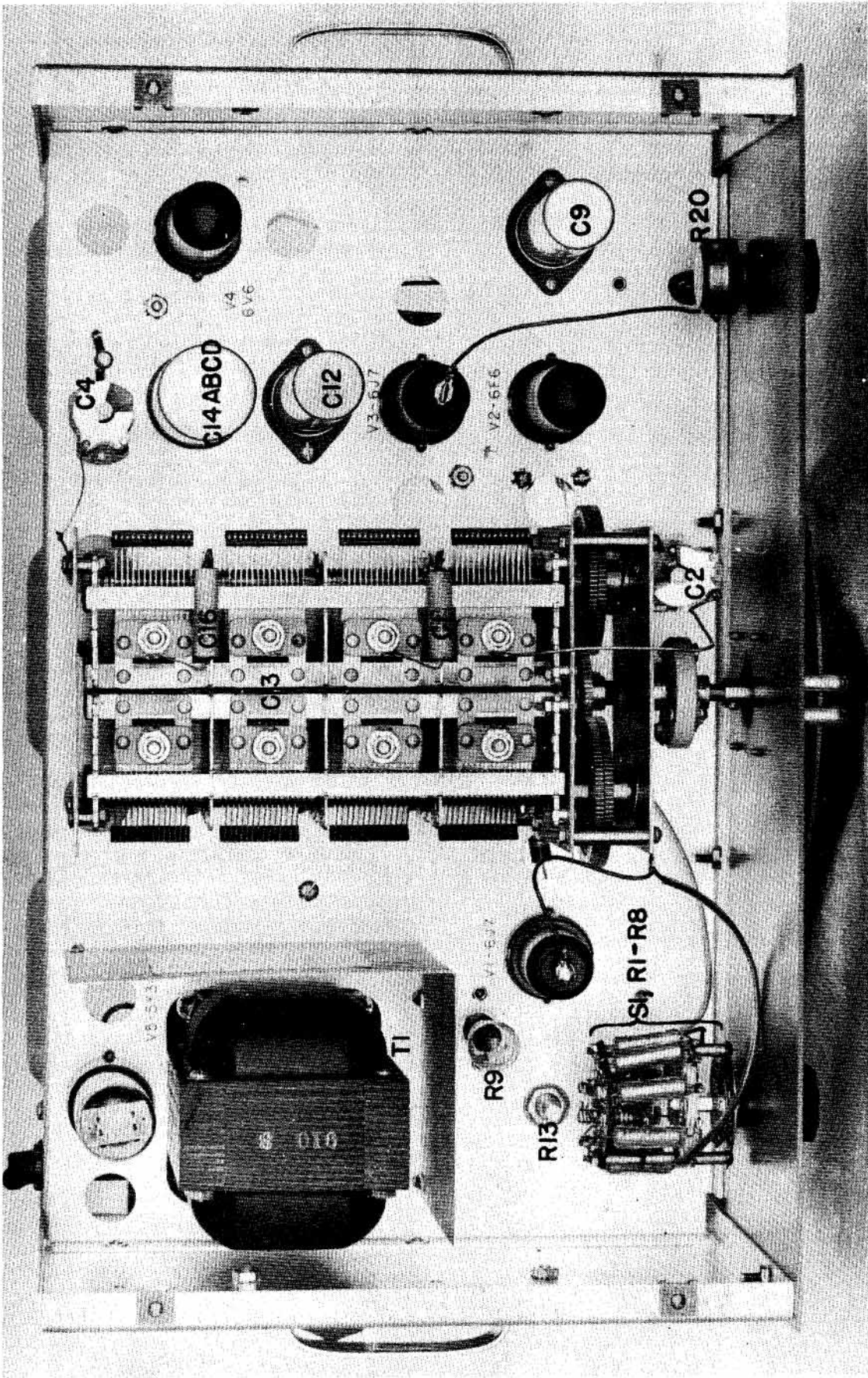

Model 200D Top View  
Cover Removed

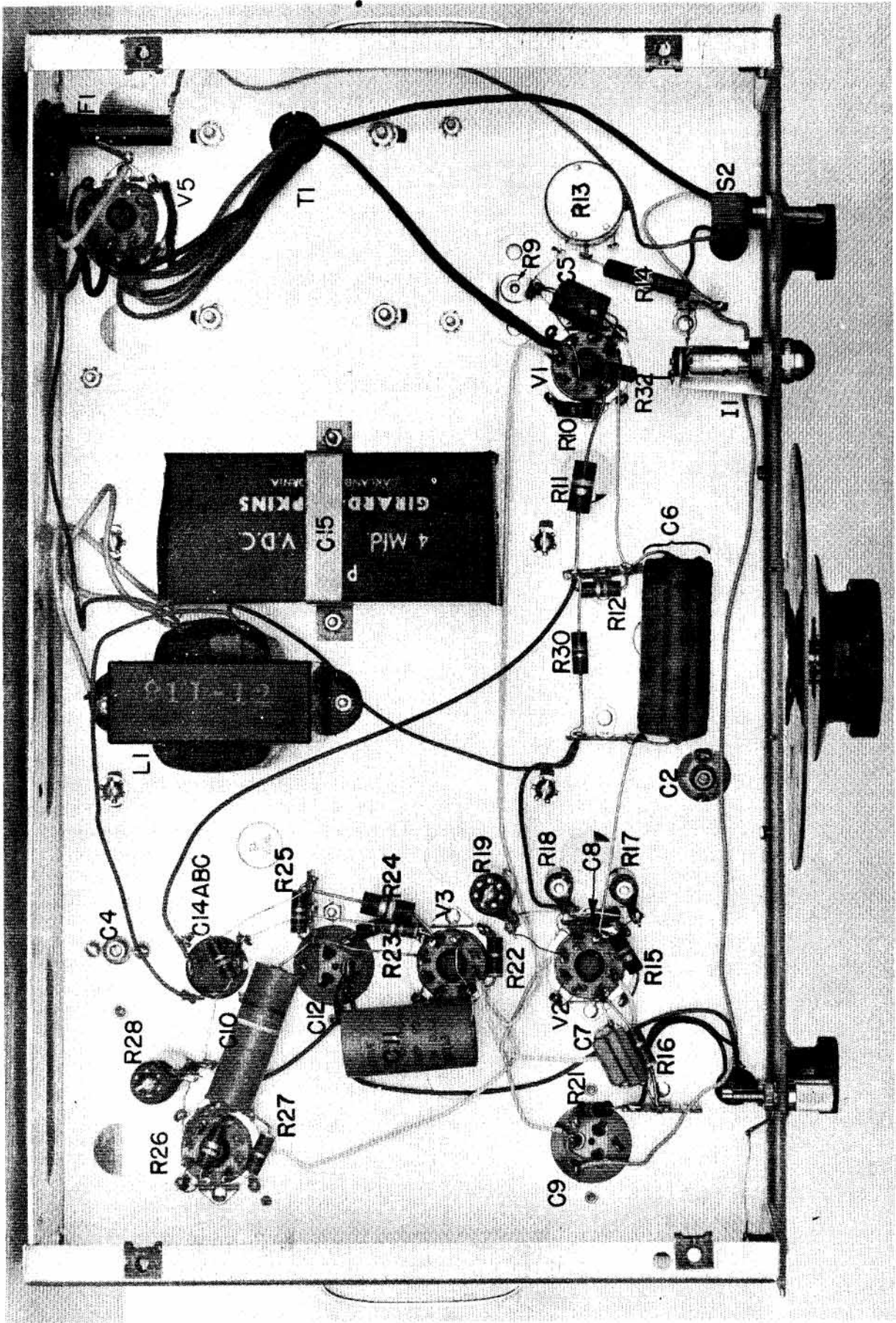

Model 200D Bottom View  
Bottom Plate Removed



TABLE OF REPLACEABLE PARTS

Circuit Ref.	Description	-hp- Stock No.	Mfr.* & Mfrs. Designation
C1 **	Capacitor: fixed, mica, 82 $\mu$ uf, $\pm 5\%$	15-7	K CI-3
C2 **	Capacitor: variable, air, 100 $\mu$ uf	12-11	AA, A-10 3L
C3 **	Capacitor: variable air, 4 sect. 525 $\mu$ uf/section, C3 is composed of two 4 section capacitors	12-6	HP
C4 **	Capacitor: variable, air, 100 $\mu$ uf	12-11	AA, A-103L
C5	Capacitor: fixed, mica, 100 $\mu$ uf Electrical value adjusted at factory	14-100	V Type OXM
C6	Capacitor: fixed, paper, .5 $\mu$ f, 600 vdcw	16-5	A Type 684
C7	Capacitor: fixed, mica, 2000 $\mu$ uf Capacitor: fixed, mica, 500 $\mu$ uf C7 = 2000 $\mu$ uf and 500 $\mu$ uf in parallel	14-13 14-500	V, Type W V, Type OXM
C8	This circuit reference not assigned		
C9	Capacitor: fixed, electrolytic, 40 $\mu$ f, 450 vdcw	18-40	X FPS-146
C10	Capacitor: fixed, paper, .1 $\mu$ f, 600 vdcw	16-1	A Type P688
C11	Capacitor: fixed, electrolytic, 10 $\mu$ f, 450 vdcw	18-10	X WB 72
C12	Capacitor: fixed, electrolytic, 40 $\mu$ f, 450 vdcw	18-40	X FPS-146
C13	This circuit reference not assigned		
C14 abcd	Capacitor: fixed, electrolytic, 20, 20, 20, 20 $\mu$ f, 450 vdcw	18-42	X FPQ-444
C15	Capacitor: fixed, paper, 4 $\mu$ f, 600 vdcw	17-3	P P8-4

\*See "list of Manufacturers Code Letters For Replaceable Parts Table."

\*\*These parts are also included in Capacitor Assembly, #D-7

TABLE OF REPLACEABLE PARTS

Circuit Ref.	Description	-hp- Stock No.	Mfr. & Mfrs. Designation
C16 **	Capacitor: fixed, mica, 51 $\mu$ uf, $\pm 5\%$	15-6	K CI-3
R1-R8	Part of Range Switch Assembly		
R9	Lamp: 6W, 120V, S6 clear bulb, Candelabra screw base	211-5	N
R10	Resistor: fixed, composition, 47,000 ohms, $\pm 10\%$ , 1W	24-47K	B GB 4731
R11	Resistor: fixed, composition, 100,000 ohms, $\pm 10\%$ , 2W	25-100K	B HB 1041
R12	Resistor: fixed, composition, 56,000 ohms, $\pm 10\%$ , 1W	24-56K	B GB 5631
R13	Resistor: variable, wirewound, 1000 ohms, linear taper	210-5	G 21-010-355
R14	Resistor: fixed, wirewound, 1500 ohms, $\pm 10\%$ , 1W	26-1500	R Type BW
R15	Resistor: fixed, composition, 560,000 ohms, $\pm 10\%$ , 1W	24-560K	B GB 5641
R16	Resistor: fixed, wirewound, 500 ohms, $\pm 10\%$ , 10W	26-5	S Type 1-3/4E
R17	Resistor: fixed, wirewound, 25,000 ohms, $\pm 10\%$ , 10W	26-11	S Type 1-3/4E
R18	Resistor: fixed, wirewound, 10,000 ohms, $\pm 10\%$ , 10W	26-10	S Type 1-3/4E
R19	Resistor: fixed, wirewound, 10,000 ohms, $\pm 10\%$ , 20W	27-4	S Type 2R
R20	Resistor: variable, composition, 25,000 ohms, linear taper	210-54	B JU 2531
R21	Resistor: fixed, composition, 10,000 ohms, $\pm 10\%$ , 1W	24-10K	B GB 1031
R22	Resistor: fixed, composition, 4700 ohms, $\pm 10\%$ , 1W	24-4700	B GB 4721

2000 10/13/50 Serial 70,000 Eo

TABLE OF REPLACEABLE PARTS

Circuit Ref.	Description	-hp- Stock No.	Mfr. & Mfrs. Designation
R23	Resistor: fixed, composition, 47,000 ohms; $\pm 10\%$ , 1W	24-47K	B GB 4731
R24	Resistor: fixed, composition, 100,000 ohms, $\pm 10\%$ , 2W	25-100K	B HG 1041
R25	Resistor: fixed, composition, 56,000 ohms, $\pm 10\%$ , 1W	24-56K	B GB 5631
R26	Resistor: fixed, composition, 560,000 ohms, $\pm 10\%$ , 1W	24-560K	B GB 5641
R27	Resistor: fixed, wirewound, 500 ohms, $\pm 10\%$ , 10W	26-5	S Type 1-3/4E
R28	Resistor: fixed, wirewound, 5000 ohms, $\pm 10\%$ , 20W	27-3	S Type 2R
R29	Resistor: fixed, composition, 10,000 ohms, $\pm 10\%$ , 1W	24-10K	B GB 1031
R30	Resistor: fixed, composition, 10,000 ohms, $\pm 10\%$ , 1W	24-10K	B GB 1031
R31	Resistor: fixed, composition, 10,000 ohms, $\pm 10\%$ , 1W	24-10K	B GB 1031
R32, R33, R34	These circuit references not assigned		
R35	Resistor: fixed, composition, 33 ohms, $\pm 10\%$ , 1W	24-33	B GB 3301
	"Ampl." Dial:	35-1	HP
	"Range" Dial:	35-10	HP
	Dial Window:	M-2	HP
	Binding Post:	312-3	HP
C1, C2, C3, C4, C16	Capacitor: Assembly:	D-7	HP
	Fixed Coupling:	M-25	HP

200D 10/13/50 Serial 70,000 to

TABLE OF REPLACEABLE PARTS

Circuit Ref.	Description	-hp- Stock No.	Mfr. & Mfrs. Designation
F1	Fuse: 1 A, 3 AG type	211-1	T, #312001
	Fuseholder:	312-8	T, #342001
	Indicator Lamp Assembly:	312-10	BB, #807BS
	Knob: 1-1/2" diam.	37-11	HP
	Knob: 3" diam.	37-14	HP
I1	Lamp: 6-8V, .15A, miniture bayonet base	211-47	O, Mazda#47
	Lampholder: for R9	38-89	Leecraft Mfg. #659-1
P1	Power Cable:	812-56	HP
L1	Reactor: 6 H @ 125 MA, 240 ohms	911-12	HP
S1, R1-R8	Range Switch Assembly:	D-19W	HP
S2	Toggle Switch: SPST	310-11	D, #20994-HW
T1	Power Transformer:	910-3	HP
V1	Tube: 6J7	212-6J7	ZZ
V2	Tube: 6F6	212-6F6	ZZ
V3	Tube: 6J7	212-6J7	ZZ
V4	Tube: 6V6	212-6V6	ZZ
V5	Tube: 5Y3GT	212-5Y3GT	ZZ

200D 10/13/50 Serial 70,000 to



LIST OF MANUFACTURERS CODE LETTERS  
FOR REPLACEABLE PARTS TABLE

<u>Code Letter</u>	<u>Manufacturer</u>
A	Aerovox Corp.
B	Allen-Bradley Co.
C	Amperite Co.
D	Arrow, Hart and Hegeman
E	Bussman Manufacturing Co.
F	Carborundum Co.
G	Centralab
H	Cinch Manufacturing Co.
I	Clarostat Manufacturing Co.
J	Cornell Dubilier Electric Co.
K	Electrical Reactance Co.
L	Erie Resistor Corp.
M	Federal Telephone and Radio Corp.
N	General Electric Co.
O	General Electric Supply Corp.
P	Girard-Hopkins
HP	Hewlett-Packard
Q	Industrial Products Co.
R	International Resistance Co.
S	Lectrohm, Inc.
T	Littelfuse, Inc.
U	Maguire Industries, Inc.
V	Micamold Radio Corp.
W	Oak Mfg. Co.
X	P. R. Mallory Co., Inc.
Y	Radio Corp. of America
Z	Sangamo Electric Co.
AA	Sarkes Tarzian
BB	Signal Indicator Co.
CC	Sprague Electric Co.
DD	Stackpole Carbon Co.
EE	Sylvania Electric Products, Inc.
FF	Western Electric Co.
GG	Wilkor Products, Inc.
HH	Amphenol
II	Dial Light Co. of America
JJ	Leecraft Manufacturing Co.
ZZ	Any tube having RMA standard characteristics

## CLAIM FOR DAMAGE IN SHIPMENT

The instrument should be tested as soon as it is received. If it fails to operate properly, or is damaged in any way, a claim should be filed with the carrier. A full report of the damage should be obtained by the claim agent, and this report should be forwarded to us. We will then advise you of the disposition to be made of the equipment and arrange for repair or replacement. Include model number, type number and serial number when referring to this instrument for any reason.

## WARRANTY

Hewlett-Packard Company warrants each instrument manufactured by them to be free from defects in material and workmanship. Our liability under this warranty is limited to servicing or adjusting any instrument returned to the factory for that purpose and to replace any defective parts thereof (except tubes, fuses and batteries). This warranty is effective for one year after delivery to the original purchaser when the instrument is returned, transportation charges prepaid by the original purchaser, and which upon our examination is disclosed to our satisfaction to be defective. If the fault has been caused by misuse or abnormal conditions of operation, repairs will be billed at cost. In this case, an estimate will be submitted before the work is started.

If any fault develops, the following steps should be taken:

1. Notify us, giving full details of the difficulty, and include the model number, type number and serial number. On receipt of this information, we will give you service instructions or shipping data.
2. On receipt of shipping instructions, forward the instrument prepaid, and repairs will be made at the factory. If requested, an estimate of the charges will be made before the work begins provided the instrument is not covered by the warranty.

## SHIPPING

All shipments of Hewlett-Packard instruments should be made via Railway Express. The instruments should be packed in a wooden box and surrounded by two to three inches of excelsior or similar shock-absorbing material.

**DO NOT HESITATE TO CALL ON US**

HEWLETT-PACKARD COMPANY  
*Laboratory Instruments for Speed and Accuracy*  
395 PAGE MILL ROAD PALO ALTO, CALIF.





OFFERS

# COMPLETE COVERAGE in electronic test instrumentation

Choose the exact electronic test equipment you need from the -hp- line — the world's most complete line of over 200 test instruments. Enjoy the engineering economies of fast, accurate measurements, sturdy dependability, broad application. Enjoy, too, the "family characteristics" of -hp- instruments—simple operation, minimum adjustment, independence of line voltage and tube changes, generous overload protection, trouble-free performance.

These pages give brief details of major -hp- instruments. For specific data or catalogs, write to factory on your letterhead or see your local -hp- representative.

## hp Oscillators — Generators — .01 to 10,000,000 cps

### -hp- 200 SERIES AUDIO OSCILLATORS



Six standard models. 200A, 200B have transformer-coupled output, deliver 1 watt into matched load. 200C, 200D and 202D (for sub-audio, audio, super-

sonic and carrier measurements) have resistance-coupled output, supply constant voltages over their entire frequency ranges. 200I, spread-scale oscillator for interpolation or where frequency must be known precisely.

### -hp- 650A TEST OSCILLATOR

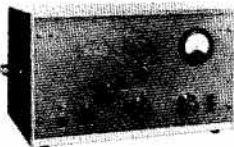

Highly stable, wide band (10 cps to 10mc) multi-purpose test oscillator for audio, super-sonic, video and rf measurements. Output flat within 1 db.

Range 0.00003 to 3 v. Output impedance 600 ohms or 6 ohms with voltage divider. \$475.00

Instrument	Primary Uses	Frequency Range	Output	Price
-hp- 200A	Audio tests	35 cps to 35 kc	1 watt/22.5v	\$120.00
-hp- 200B	Audio tests	20 cps to 20 kc	1 watt/22.5v	\$120.00
-hp- 200C	Audio and supersonic tests	20 cps to 200 kc	100 mw/10v	\$150.00
hp- 200D	Audio and supersonic tests	7 cps to 70 kc	100 mw/10v	\$175.00
-hp- 200H	Carrier current, telephone tests	60 cps to 600 kc	10 mw/1v	\$350.00
-hp- 200I	Interpolation and frequency measurements	6 cps to 6 kc	100 mw/10v	\$225.00
-hp- 201B	High quality audio tests	20 cps to 20 kc	3w/42.5v	\$250.00
-hp- 202A	Low frequency measurements	.01 cps to 1 kc.	20 mw/10v	\$450.00
-hp- 202B	Low frequency measurements	1/2 cps to 50 kc	100 mw/10v	\$350.00
-hp- 202D	Low frequency measurements	2 cps to 70 kc	100 mw/10v	\$275.00
-hp- 204A	Portable, battery operated	2 cps to 20 kc	2.5 mw/5v	\$175.00
-hp- 205A	High power audio tests	20 cps to 20 kc	5 watts	\$390.00
-hp- 205AG	High power tests, gain measurements	20 cps to 20 kc	5 watts	\$425.00
-hp- 205AH	High power supersonic tests	1 kc to 100 kc	5 watts	\$550.00
-hp- 206A	High quality high accuracy audio tests	20 cps to 20 kc	+15 dbm	\$550.00
-hp- 650A	Wide range video tests	10 cps to 10 mc	15 mw/3v	\$475.00

## hp Vacuum Tube Voltmeters — 2 to 700,000,000 cps

### -hp- 410B VACUUM TUBE VOLTMETER



Wide range, flat response performance 20 cps to 700 mc. Convenient, simple to use, occupies minimum bench space. Handy compartment for detachable probe and leads. Diode probe design places approxi-

mately 1.3  $\mu$ fd capacity across circuit under test. This, plus high shunt impedance (10 megohms at low frequencies) means circuits under test are not disturbed, and true voltage readings are assured. 1 db accuracy, 20 cps to 700 mc. Also measures dc voltage to 1000 v and resistances to 500 megohms. \$245.00

Instrument	Primary Uses	Frequency Range	Voltage Range	Input Impedance	Price
-hp- 400A	General purpose ac measurements	10 cps to 1 mc	.005 to 300 v 9 ranges	1 megohm 24 $\mu$ fd shunt	\$185.00
-hp- 400B	Low frequency ac measurements	2 cps to 100 kc	.005 to 300 v 9 ranges	10 megohms 24 $\mu$ fd shunt	\$195.00
-hp- 400C	Wide range ac measurements High sensitivity	20 cps to 2 mc	.0001 to 300 v 12 ranges	10 megohms 15 $\mu$ fd shunt	\$200.00
-hp- 404A	Portable, battery operated	2 cps to 50 kc	.0005 to 300 v 11 ranges	10 megohms 20 $\mu$ fd shunt	\$185.00
-hp- 410B	Audio, rf, VHF measurements; dc voltages; resistances	20 cps to 700 mc	.1 to 300 v 7 ranges	10 megohms 1.3 $\mu$ fd shunt	\$245.00

-hp- Voltmeter Accessories (not listed) include voltage dividers, connectors, shunts and multipliers to extend useful range of your equipment.

Data Subject to Change Without Notice. Prices f. o. b. Factory.

HEWLETT-PACKARD



INSTRUMENTS

# hp Signal Generators — 10 to 7,600 mc

## -hp- 618A SHF SIGNAL GENERATOR

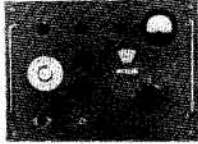

3,800 to 7,600 mc. Provides a 1 mw signal into a 50-ohm coaxial load (zero dbm). Output attenuator directly calibrated in dbm and volts, reduces output level to less than -100 dbm. Frequency dial directly calibrated, accuracy 1/2 of 1%. Repeller voltage automatically tracked. No adjustment during operation. CW, pulsed and FM output. \$2,250.00

Instrument	Frequency	Characteristics	Price
-hp- 608A	10 to 500 mc	Output 1 v to .1 $\mu$ v. Amplitude modulated, pulsed and CW output. Direct reading.	\$850.00
-hp- 610B	.450 to 1,200 mc	Calibrated output, .1 v to .1 $\mu$ v. Internal pulse modulation. Direct calibration	\$925.00
-hp- 614A	800 to 2,100 mc	Direct reading. Pulse modulation, CW & FM. Output 1 mw or .223 v to .1 $\mu$ v	\$1,950.00
-hp- 616A	1,800 to 4,000 mc	Direct reading. Pulse modulation, CW & FM. Output 1 mw or .223 v to .1 $\mu$ v	\$1,950.00
-hp- 618A	3,800 to 7,600 mc	Direct reading. External pulse modulation, CW & FM. Output .223 v to 2.23 $\mu$ v	\$2,250.00

# hp Distortion, Wave Form Analyzers — 20 cps to 20 kc

## -hp- 330B DISTORTION ANALYZER

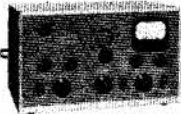

Measures distortions as low as 0.1% at any frequency, 20 cps to 20 kc. Measures noise voltages as low as 100  $\mu$ v. High sensitivity, high stability, broad applicability for broadcast, laboratory or production problems. Wide band 20 db gain input amplifier. Built-in vacuum tube voltmeter usable separately. \$395.00

Analyzer	Primary Uses	Frequency Range	Characteristics	Price
-hp- 300A	Wave form analyzer	30 cps to 16 kc	Variable selectivity; measuring range 1 mv to 500 v.	\$625.00
-hp- 320A	Measures total distortion	400 cps and 5 kc	Requires external detector	\$ 75.00
-hp- 320B	Measures total distortion	50, 100, 400 cps, 1, 5 and 7.5 kc	Same as above	\$150.00
-hp- 330B	Measures total distortion	20 cps to 20 kc	Includes input amplifier, VTVM	\$395.00
-hp- 330C	For FM measurements	20 cps to 20 kc	Special VU meter to meet F. C. C. requirements	\$425.00
-hp- 330D	For AM, FM measurements	20 cps to 20 kc	AM detector and VU meter to meet F. C. C. requirements	\$440.00

### FM, AM-FM MODELS

-hp- 330C, for FM broadcasters, includes VU meter meeting F. C. C. requirements. -hp- 330D, for AM-FM broadcasters, includes AM detector to rectify AM carrier, plus VU meter employed in model 330C. 330C, \$425.00. 330D, \$440.00

### SQUARE WAVE GENERATOR

-hp- 210A	Transient and frequency response	20 cps to 10 kc	Output 50 v. peak-to-peak. 1,000 ohm impedance	\$150.00
-----------	----------------------------------	-----------------	--	----------

# hp Frequency Measuring Equipment — .01 cps to 10 mc



## -hp- 524A FREQUENCY COUNTER

Instantly, automatically, directly measures unknown frequencies, 0.01 cps to 10 mc!

One instrument combines functions of frequency standard, interpolating system and detector! Amazingly simple operation — just connect unknown to input terminal, and exact frequency appears automatically on front panel. High speed decade scalers count unknown frequency over measured, crystal-controlled time interval. Accuracy of measurement  $\pm 1$  count  $\pm$  crystal stability (2/1,000,000 per week). External higher accuracy standard usable if desired. Minimum of unknown, 1 v peak. \$2,000.00

Instrument	Primary Uses	Frequency Range	Characteristics	Price
-hp- 524 Frequency Counter	Frequency, interval, time measurements	.01 cps to 10 mc	Direct reading, no interpolation, accuracy about 2/1,000,000	\$2,000.00
-hp- 100D Secondary Standard	Frequency, time measurements	100 kc, 10 kc, 1 kc, 100 cps, 10 cps	Stability 1/1,000,000 (short-time). Sine or rectangular output. Marker pips.	\$ 600.00
-hp- 100C Secondary Standard	Audio, supersonic calibration	100 kc, 10 kc, 1 kc, 100 cps	Accurate within $\pm .001\%$ . Sine waves only.	\$ 450.00
-hp- 500A Frequency Meter	Rapid frequency measurements	5 cps to 50 kc	10 ranges $\pm 2\%$ accuracy. Input 0.5 to 200 volts.	\$ 210.00
-hp- 505A Tachometer	Measurements of high speed machinery	300 to 3,000,000 rpm	10 ranges $\pm 2\%$ accuracy.	\$ 300.00
-hp- 505B Tachometer	Same as above	5 to 50,000 rps	Same as 505A except calibrated in rps.	\$ 300.00

## -hp- 100D SECONDARY FREQUENCY STANDARD



Swift, sure frequency comparison, new convenience in standardizing with minimum external equipment. 100  $\mu$ sec time markers, built-in oscilloscope, sine or rectangular waves. Low output impedance, short-time stability 1/1,000,000. Performs most functions of expensive primary standards in audio, rf or supersonic ranges. \$600.00

Frequency monitors available for FM broadcast, 88 to 108 mc, TV aural broadcast 59.75 to 215.75 mc; and for communications systems, 30 to 175 mc.

Data Subject to Change Without Notice. Prices f. o. b. Factory.

# Complete Coverage! HEWLETT-PACKARD



# Microwave Test Equipment—10 to 18,000 mc!

Basic, low cost elements offer utmost flexibility for assembly of exact instrumentation required. Each unit covers entire range of its waveguide size. Simple, sturdy mechanical design; accurate, multi-purpose operation.

Instrument	Coaxial Type N. Conn.	"S" 3" x 1 1/2" 2.6 - 3.95 kmc.	"G" 2" x 1" 3.95 - 5.85 kmc.	"J" 1 1/2" x 3/4" 5.85 - 8.2 kmc.	"H" 1 1/4" x 3/8" 7.05 - 10.0 kmc.	"X" 1" x 1/2" 8.2 - 12.4 kmc.	"P" .702" x .391" 12.4 - 18.0 kmc.
Adaptors, Waveguide to Coax		S281A \$75.00	G281A \$55.00	J281A \$50.00	H281A \$45.00	X281A \$35.00	
Cover to choke flange		S290A \$40.00	G290A \$30.00	J290A \$25.00	H290A \$20.00	X290A \$15.00	P290A \$20.00
Attenuators, Fixed 6, 10, 20 db		S370 \$75.00	G370 \$65.00	J370 \$65.00	H370 \$60.00	X370 \$55.00	P370 \$60.00
Flap, 25 db max.		S375A \$75.00	G375A \$65.00	J375A \$60.00	H375A \$55.00	X375A \$50.00	P375A \$55.00
Calibrated		S380A \$225.00					
Detector Mounts	440A† \$85.00	S485A* \$125.00	G-485B† \$95.00	J485B† \$90.00	H485B† \$85.00	X485B† \$75.00	
Frequency Meters, Reaction				J530A \$120.00	H530A \$120.00	X530A \$120.00	
Slotted Sections	806B§ \$200.00	S810A* \$450.00	G810B§ \$90.00	J810B§ \$90.00	H810B§ \$90.00	X810B§ \$90.00	
Waveguide Tees, Series		S840A \$60.00	G840A \$50.00	J840A \$40.00	H840A \$35.00	X840A \$30.00	P840A \$35.00
Shunt		S841A \$60.00	G841A \$50.00	J841A \$40.00	H841A \$35.00	X841A \$30.00	P841A \$35.00
Hybrid		S845A \$90.00	G845A \$75.00	J845A \$60.00	H845A \$55.00	X845A \$45.00	P845A \$55.00
Transformers, Slide-screw		S870A \$150.00	G870A \$140.00	J870A \$135.00	H870A \$130.00	X870A \$125.00	P870A \$130.00
E-H		S880A \$175.00	G880A \$155.00	J880A \$145.00	H880A \$135.00	X880A \$130.00	P880A \$135.00
Adjustable Shorts		S920A \$80.00	G920A \$70.00	J920A \$65.00	H920A \$60.00	X920A \$50.00	P920A \$55.00
Terminations, Low Power		S910A \$45.00	G910A \$40.00	J910A \$35.00	H910A \$30.00	X910A \$25.00	P910A \$30.00
Terminations, High Power		S912A \$125.00				X912A \$75.00	
Broad Band Probe	442A \$75.00			All Frequencies			
Broad Band Probe, Untuned	444A \$50.00			All Frequencies			

\*For use with bolometer only.

†For use with bolometer or crystal.

‡Complete assembly including carriage.

§Mounts in 809B carriage

## -hp- 809B UNIVERSAL PROBE CARRIAGE

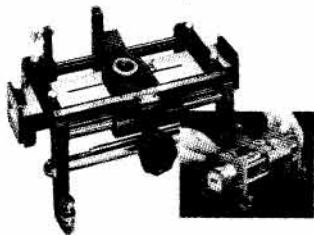

Now—a single all-purpose probe carriage operates with 5 different -hp- slotted sections—waveguide and coaxial. Mounts sections covering frequencies 3,000 to 12,400 mc—sections can be interchanged in 30 seconds! Carriage calibrated in mm. to 0.1 mm.; dial gauge may be mounted for more accurate readings. Operates with -hp- 442A

Broad Band Probe and -hp- 440A Coaxial Detector in combination; or with -hp- 444A Untuned Probe. -hp- 809B, \$160.00

## -hp- COAXIAL SLOTTED SECTIONS

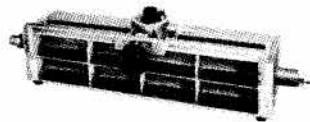

-hp- 805A/B. 500 to 4,000 mc. High accuracy, high stability, negligible slope, minimum leakage. Exclusive parallel plane design with non-bowing central conductor. VSWR of basic section and connectors less than 1.04. -hp- 805A, 50 ohms, Type N connector, for flexible cables. -hp- 805B, 46.3 ohms, for 3/4" rigid transmission lines. \$475.00

-hp- 806B. 3,000 to 12,000 mc. Same parallel plane design as 805A/B. For use with 809B Carriage. VSWR of section and connectors 1.06 to 10,000 mc. 50 ohm impedance, negligible slope. Type N connectors for flexible cable. \$200.00



-hp- 803A VHF Bridge reads impedance magnitude and phase direct, 10 to 500 mc. Rapid operation, for comparative measurements 5 to 1,000 mc. Impedance range 2 to 2,000 ohms. Phase angle -90° to +90° at 52 mc and above. \$495.00

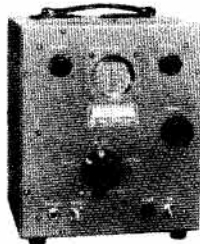

-hp- 417A VHF Detector, for use with 803A Bridge; or general laboratory readings. Super-regenerative receiver, 10 to 500 mc, 5 bands. Approx. 5 μV sensitivity over entire band. Direct reading frequency control, thoroughly shielded. \$200.00

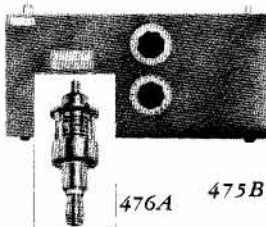

New -hp- 476A Universal Bolometer Mount measures rf power 10 to 1,000 mc. No tuning or adjustment. VSWR less than 1.15, 20 to 500 mc; 1.25, 10 to 1,000 mc. \$125.00. -hp- 475B Tunable Mount, continuous 1,000 to 4,000 mc. \$200.

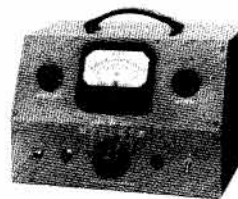

-hp- 430A Microwave Power Meter provides instantaneous rf power readings direct in db or mw at all bolometer mount frequencies. No calculations, no adjustment except zero set. For -hp- bolometer mounts: 475B, 476A, 485. \$250.00



-hp- 415A Standing Wave Indicator for all waveguide or coaxial slotted sections. Gives direct readings in VSWR or db. Single frequency operation; 300 to 2,000 cps. Low noise level, 0.3 μV sensitivity, 60 db calib. attenuator. \$200.00

Data Subject to Change Without Notice. Prices f. o. b. Factory.



# INSTRUMENTS Complete Coverage!

## -hp- AMPLIFIERS



Complete instrumentation for distortion-free, fast pulse measurement. **-hp- 460A Wide Band Amplifiers**, in cascade with **-hp- 460B Fast-Pulse Amplifiers** offer up to 90 db gain, 125 volts open circuit output. This permits full deflection of 5XP CRT, or 2-inch deflection of 5CP tubes. Rise time 0.0026  $\mu$ sec; can amplify milli-microsecond pulses; gives over 100 mc bandwidth to your standard oscilloscope. 460A, \$185.00; 460B, \$225.00. Connecting cables, plugs, accessories—prices on request.

**-hp- 450A Amplifier**—general purpose instrument, 20 db or 40 db gain, for use wherever wide frequency range and high stability are needed. 10 cps to 1 mc. Negligible phase shift, no spurious responses. \$140.00

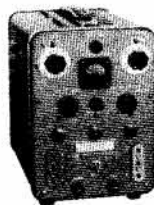

## -hp- POWER SUPPLIES

**-hp- 715A** (illustrated) is a versatile source of regulated beam and reflector voltage for operating most test bench klystron tubes. Beam voltage 250 to 400 v; reflector voltage 10 to 900 v; 6.3 v filament. Internal, 1,000 cps square wave modulation, also 60 cps FM modulation, both on reflector voltage. \$300.00

**-hp- 710A**—Highly stable regulated dc supply, output variable 180 to 360 v at 75 ma., 6.3 v filament. Either terminal may be grounded. Total hum and noise less than 5 mv. \$85.00

**-hp- 712A**. Stabilized, variable power supply providing 0 to 500 v at 200 ma and 1/2% regulation. Also variable bias voltages, 0 to 150 v at 5 ma, and 6.3 v filament at 10 amps. Main supply completely metered. Either terminal may be grounded. Hum less than 8 mv. For laboratory, production or general use. \$350.00

## -hp- 520A NUCLEAR SCALER



**-hp- 520A** is a new, high-speed 10 mc scaler offering utmost reliability in nuclear counting and frequency measurements. Capable of scaling pulses at rates up to 10,000,000 pps. Has double-pulse resolving time of 0.1  $\mu$ sec; triple-pulse resolving time of

0.2  $\mu$ sec. Two-decade circuit gives scaling factor of 100; residual counts are indicated by two panel meters with combined capacity of 100 counts. Instrument may be used with existing low speed scalers to provide any desired count capacity. \$600.00

## -hp- 212A PULSE GENERATOR

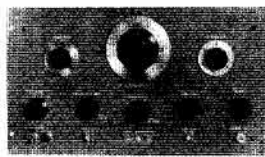

Provides continuously variable, high power "fast pulses" of superior wave form. Combines broad general usefulness with 0.02  $\mu$ sec rise and decay time to meet requirements of radar, TV and nuclear work. Pulse length variable 0.07 to 10  $\mu$ sec;

minimum overshoot; 50 watt peak power (50 v to 50 ohms loads). Low impedance means accurate pulses can be delivered at a distance from the instrument. Repetition rate variable 50 to 5,000 pps; controlled internally or externally. Synchronizing pulses available in advance of, or following, output pulse. \$550.00

*Data Subject to Change Without Notice. Prices f. o. b. Factory.*



# offers COMPLETE COVERAGE

in convenient "next door" service!

**-hp-** has selected the best independent organizations in America to give you personal help with measuring problems. Electronics specialists—men trained by Hewlett-Packard—save you time by helping select exact **-hp-** instrumentation you need. These men are located in major business centers—as near as your telephone. Call them when you need personal help—in your plant—today!



**Albuquerque, New Mexico**  
Neely Enterprises  
107 S. Washington St.  
Albuquerque 5-8731

**Boston 16, Massachusetts**  
Burlingame Associates  
270 Commonwealth Ave.  
KENmore 6-8100

**Chicago 40, Illinois**  
Alfred Crossley & Associates  
4501 Ravenswood Ave.  
UPtown 8-1141

**Cleveland 15, Ohio**  
M. P. Odell Co.  
2536 Euclid Ave.  
PRospect 1-6171

**Dallas 5, Texas**  
Earl Lipscomb Associates  
3561 Marquette St.  
P. O. Box 8042  
EMerson 6-7989

**Dayton 2, Ohio**  
Alfred Crossley & Associates  
410 W. First St.  
Michigan 8721

**Denver 3, Colorado**  
Ronald G. Bowen  
852 Broadway  
AComa 5211

**Detroit 5, Michigan**  
S. Sterling Company  
13331 Linwood Ave.  
TOWnsend 8-3130

**Fort Myers, Florida**  
Arthur Lynch & Associates  
P. O. Box 466  
Fort Myers 5-6762

**Houston 5, Texas**  
Earl Lipscomb Associates  
2420-B Rice Blvd.  
P. O. Box 6573  
LInden 9303

**High Point, North Carolina**  
Bivins & Caldwell  
Room 807, Security Bank Bldg.  
High Point 3672

**Los Angeles 46, California**  
Neely Enterprises  
7422 Melrose Ave.  
WHITney 1147

**New York 13, New York**  
Burlingame Associates  
103 Lafayette St.  
DIgby 9-1240

**Philadelphia 44, Penn.**  
Burlingame Associates  
422 West Coulter St.  
TEnnessee 9-2006

**Sacramento, California**  
Neely Enterprises  
309 Ochsner Bldg.  
GILbert 3-7461

**San Francisco 18, California**  
Neely Enterprises  
2830 Geary Blvd.  
WALnut 1-3960

**St. Louis 3, Missouri**  
Harris-Hanson Company  
208 North 22nd St.  
MAIn 5464

**Syracuse 2, New York**  
Burlingame Associates  
712 State Tower Bldg.  
SYracuse 2-0194

**Toronto 2-B Ontario, Canada**  
Atlas Radio Corporation, Ltd.  
560 King St., West  
WAverley 4761

**Washington 9, D. C.**  
Burlingame Associates  
2017 S Street N. W.  
DEcatur 8000

## HEWLETT-PACKARD COMPANY

2310 PAGE MILL ROAD • PALO ALTO, CALIFORNIA, U. S. A.  
Export: Frazar & Hansen, Ltd., San Francisco, New York, Los Angeles

# HEWLETT-PACKARD



# INSTRUMENTS